

Earth Station Verification Test Overview

The material contained within this document is proprietary information, which is the property of SES and is protected as an unpublished work under the applicable copyright laws.

SES
Rooseveltpantsoen 4
2517 KR The Hague
THE NETHERLANDS

Telephone: [+31]-70-306 4100 Fax: [+31]-70-306 4101

©SES 2006

TABLE OF CONTENTS

1	INTRODUCTION	4
1.1	SCOPE	4
1.2	MEASUREMENT PHILOSOPHY	4
2	MANDATORY TESTS	5
2.1	ON-AXIS TX CROSS-POLARISATION ISOLATION	5
2.1.1	<i>Linear Polarisation</i>	5
2.1.2	<i>Circular Polarisation</i>	6
2.2	RX FIGURE OF MERIT	6
2.2.1	<i>Rx Gain and System Temperature Method</i>	6
2.2.2	<i>Spectrum Analyser Method</i>	9
2.3	EIRP STABILITY	10
2.4	SPECTRAL SHAPE	10
3	ADDITIONAL TESTS	11
3.1	TX ANTENNA PATTERNS	11
3.1.1	<i>Co-Polarised Antenna Pattern</i>	11
3.1.2	<i>Cross-Polarised Patterns</i>	12
3.2	RX ANTENNA PATTERNS	12
3.2.1	<i>Co-Polarised Antenna Pattern</i>	12
3.2.2	<i>Cross-Polarised Antenna Pattern</i>	13
3.3	TX CROSS-POLARISATION ISOLATION	13
3.3.1	<i>Linearly Polarised</i>	13
3.3.2	<i>Circularly Polarised</i>	14
3.4	RX CROSS-POLARISATION ISOLATION	14
3.4.1	<i>Linearly Polarised</i>	14
3.4.2	<i>Circularly Polarised</i>	15
	APPENDIX A: G/T MEASUREMENT PROCEDURES	16
A.1	G/T MEASUREMENT USING A SPECTRUM ANALYSER	17

1 INTRODUCTION

1.1 SCOPE

This document describes an **overview** of the measurement procedures that the SES Payload Management and Operations Center (PMOC) follow in order to verify the performance of new and existing antennas which have not been characterised entering the SES system.

1.2 MEASUREMENT PHILOSOPHY

SES has developed an efficient and commercially oriented earth station verification strategy, which is based around the following assumptions:

- Transmit stations larger than 3.8 m will be required to be specifically verified. The tests to be performed will be determined by SES on a case-by-case basis. The requested tests will be sufficient to ensure that the efficiency of intra system spectrum utilisation can be maintained under all potential operational conditions, and to verify compliance with radio regulations (e.g. test over full frequency band).
- Stations with the potential to radiate with a power flux density close to the specified ITU-R/RR/ETSI limits, or stations intending to support a significant fraction of any transponder capacity, such as hubs and fixed broadcast uplinks, will be required to perform a complete series of tests. The tests to be performed will be determined by SES on a case-by-case basis.
- Smaller stations such as certain VSAT terminals with a limited EIRP capability can be introduced into the network with a minimal set of tests. Tests will be sufficient to verify non-interference to existing users and correct station operation/link margin. Normally this testing will occur at the time of line-up.

2 MANDATORY TESTS

As stated in Section 1.2, SES has developed its own earth station verification strategy, which has resulted in a reduction in the number of mandatory measurements requested by SES.

The mandatory measurements are listed below:

- On-Axis Tx Cross-Polarisation Isolation
- Rx Figure of Merit
- EIRP Stability
- Spectral Shape

These measurements are summarised in the subsequent sections.

2.1 ON-AXIS TX CROSS-POLARISATION ISOLATION

Typically, SES will only request that the transmit cross-polarisation isolation be measured at on-axis. This is to ensure that the power level of the cross-polarised component will cause no or negligible interference to other system users.

However, SES reserve the right to request that a full transmit cross-polarisation isolation measurement is performed if deemed necessary by SES.

2.1.1 Linear Polarisation

This test procedure requires the PMOC to receive an unmodulated carrier transmitted from the Antenna Under Test (AUT) and to measure the transmit cross-polarisation isolation. Figure 2.1-1 illustrates the Tx cross-polarisation test configuration.

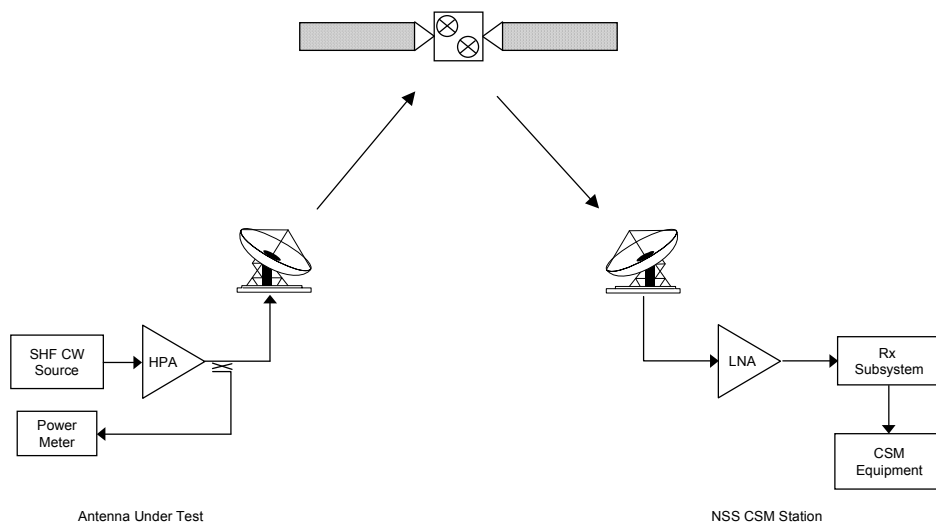

Figure 2.1-1: On-Axis Tx Cross-Polarisation Isolation Test Configuration

Prior to commencing the test, SES PMOC will ensure that the test slot as defined in the test plan is clear and free for use. PMOC will then configure the CSM to measure the co-polarisation and cross-polarisation components of the AUT's carrier.

Under the control of PMOC, the AUT will transmit a low-level test carrier at the test frequency and an initial power level 15dB below that defined in the test plan. If necessary, the PMOC will instruct the AUT to adjust the carrier level.

The PMOC will then verify that the AUT is on boresight by observing the change in the co-polarised carrier power level as the AUT is driven off boresight in azimuth and elevation. Once the AUT has been verified at boresight, the PMOC will then optimise the AUT's polarisation angle by observing the power level of the cross-polarised component as the AUT rotates the feed, and determining the polarisation angle corresponding to the minimum power level of the cross-polarised component.

The PMOC then calculates the on-axis transmit cross-polarisation isolation and determines whether or not the measured AUT's cross-polarisation isolation meets the on-axis transmit cross-polarisation isolation requirements specified by SES.

2.1.2 Circular Polarisation

The test configuration and method for circularly polarised antennas is identical to that of linearly polarised antennas (ref: 2.1.1), with the exception that there is no need to perform the polarisation angle optimisation, as this will have no effect.

2.2 RX FIGURE OF MERIT

Two methods of determining the Rx G/T of the AUT are summarised below:

- Rx Gain and System Temperature Method
- Spectrum Analyser Method

Both methods are suitable for antennas that do not employ tracking systems, although the Rx gain for a non-tracking system would be limited to the pattern beamwidth method.

Although the use of radio stars is an alternative and accurate method of measuring G/T it has not been described here because it is only applicable to a small subset of very large aperture antennas with expected G/T values exceeding 36 dB/K. However, the use of radio stars to measure G/T is acceptable to SES.

ITU Recommendation S.733-1 describes the method of measuring G/T using radio stars.

2.2.1 Rx Gain and System Temperature Method

This test procedure requires the AUT to measure its Rx gain and system noise temperature, and then by subtracting the measured results obtain the G/T.

Rx Gain

Two direct methods of measuring the Rx gain can be used; integration of the Rx sidelobe pattern or by determination of the 3dB and 10dB beamwidths. The use of pattern integration will produce the more accurate results but would require the AUT to have a tracking system. In both cases the test configurations for measuring Rx gain are identical, and are illustrated in Figure 2.2-1 below.

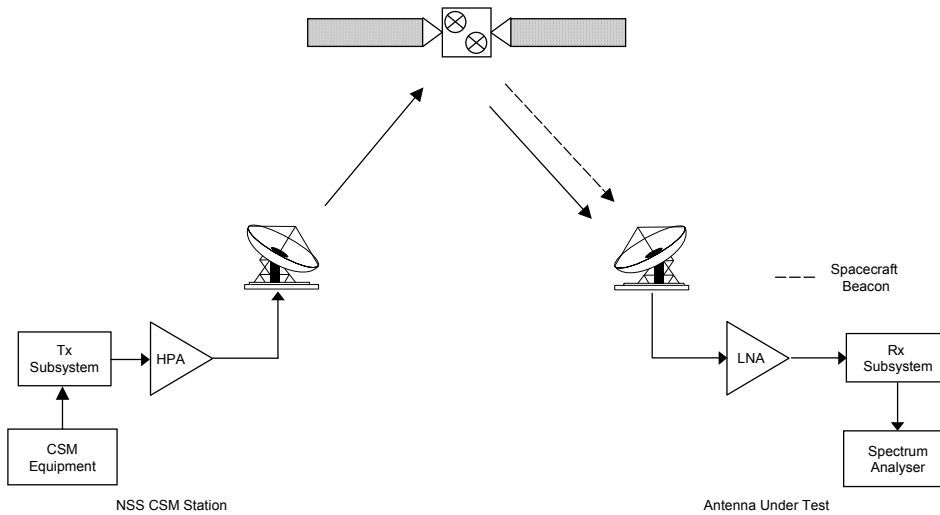

Figure 2.2-1: Rx Gain Test Configuration

In order to measure the Rx gain using pattern integration the AUT measures the elevation and azimuth narrowband ($\pm 5^\circ$ corrected) sidelobe patterns. For antennas employing elevation over azimuth mounts, the azimuth angle needs to be corrected for the elevation angle using the formula below.

$$Az' = 2\text{Sin}^{-1}\left(\text{Sin}\left(\frac{Az}{2}\right) \cdot \text{Cos}(El)\right) \quad \text{degrees}$$

where: Az is the azimuth angle from boresight as read from the encoders ($^\circ$)

El is the elevation angle ($^\circ$)

Az' is the actual azimuth angle from boresight ($^\circ$)

The AUT then calculates the directive gain of the antenna through integration of the sidelobe patterns. The Rx gain is then determined by reducing the directive gain by the antenna inefficiencies.

In order to measure the Rx gain using the beamwidth method, the AUT measures the corrected azimuth and elevation 3dB/10dB beamwidths. From these results the Rx gain of the antenna can be directly calculated using the formula below.

$$G = 10\text{Log}_{10}\left[\frac{1}{2}\left(\frac{31000}{(Az_3)(El_3)} + \frac{91000}{(Az_{10})(El_{10})}\right)\right] - F_{\text{Loss}} - R_{\text{Loss}} \quad \text{dBi}$$

where: G is the effective antenna gain (dBi)

Az₃ is the corrected azimuth 3dB beamwidth ($^\circ$)

El₃ is the elevation 3dB beamwidth ($^\circ$)

Az₁₀ is the corrected azimuth 10dB beamwidth ($^\circ$)

El₁₀ is the elevation 10dB beamwidth ($^\circ$)

F_{Loss} is the insertion loss of the feed (dB)

R_{Loss} is the reduction in antenna gain due to reflector inaccuracies, and is given by:

$$R_{Loss} = 4.922998677(S_{dev}f)^2 \quad \text{dB}$$

where: S_{dev} is the standard deviation of the actual reflector surface (inches)

f is the frequency (GHz)

System Noise Temperature

The system noise temperature can be calculated from measurement of the difference in noise power when the input to the receive system is terminated in hot and cold loads. This is known as a Y-factor measurement, where Y represents the difference in the noise power. The test configuration for measuring the system noise temperature is illustrated in Figure 2.2-2 below.

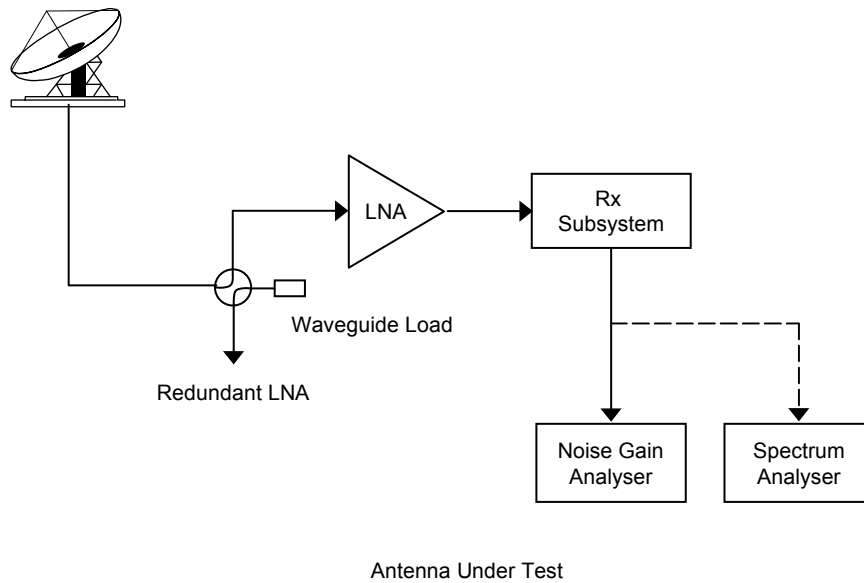

Figure 2.2-2: System Noise Temperature Test Configuration

In the above test configuration, a spectrum analyser could be used as a less accurate alternative to the noise gain analyser.

In order to measure the system noise temperature the AUT is pointed to clear sky, and the antenna is then considered to be the cold load. An input waveguide load at ambient temperature provides the hot load. This waveguide load typically forms an integral part of the LNA redundancy switching system, and can be switched in out using the LNA controller.

The AUT switches the LNA input to the ambient load and measures the noise power exhibited due to the hot load. The AUT then switches the LNA input to the antenna and measures the noise power exhibited due to the cold load. The difference between the measurements is the Y-factor.

Using the measured Y-factor, the temperature of the hot load (ambient) and the LNA temperature (manufacturer's results) the system temperature can be calculated using the formula below.

$$T_{sys} = \left(\frac{T_{Load} + T_{LNA}}{Y} \right) \quad \text{K}$$

where: T_{Load} is the noise temperature of the waveguide / test load (K)

T_{LNA} is the noise temperature of the LNA (K)

Y is the Y-factor expressed as a ratio

Rx G/T

The Rx G/T is calculated using the formula below.

$$\left(\frac{G}{T}\right) = G_{Rx} - 10\text{Log}_{10}(T_{sys}) \quad \text{dB / K}$$

where: G_{Rx} is the receive gain of the antenna (dBi)

T_{sys} is the receive system noise temperature (K)

2.2.2 Spectrum Analyser Method

Measurement of the G/T can be made directly using a spectrum analyser. In essence the downlink C/No and the corresponding satellite EIRP are measured and the G/T is obtained by re-arranging the downlink equation. Although relatively simple to perform, the measured G/T is susceptible to variations in atmospheric loss, which reduces the accuracy of the measured result. The test configuration for measuring the G/T is illustrated in Figure 2.2-3 below.

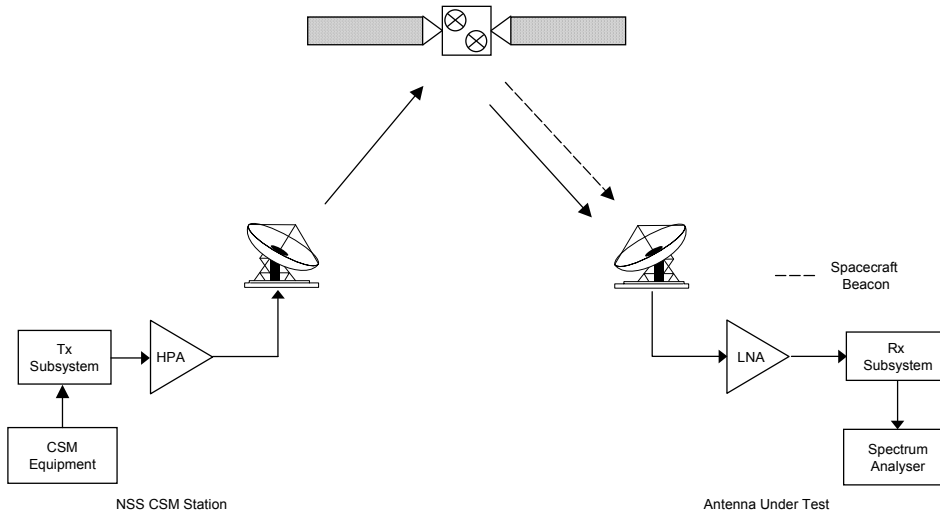

Figure 2.2-3: Rx G/T Test Configuration

The AUT measures the received power level of either an unmodulated beacon, or a test carrier provided by the PMOC. The PMOC measures the downlink EIRP of the unmodulated beacon or the test carrier.

The receive system noise contribution is then measured by steering the antenna off the spacecraft and measuring the noise floor. Alternatively, if the AUT antenna aperture is less than 4.5m it is not normally necessary to point the antenna at clear sky, but to make the measurement in the nearest guard band to the test carrier. The PMOC will advise.

The difference between the two measurements is the downlink (C+N)/N ratio. From this the downlink C/No is calculated by taking into account corrections required for the effects of the system thermal noise, spectrum analyser detection non-linearities and the spectrum analyser noise bandwidth.

The Rx G/T is then calculated by solving the downlink equation for the earth station Rx G/T.

A step by step procedure is provided in Appendix A.

2.3 EIRP STABILITY

The stability of EIRP is of great importance to the quality of service that can be provided on the system, particularly in high usage transponders or for high power uplinks.

The allowable EIRP stability is necessarily less than the allowable PFD variation at the satellite. This is in order to make a contribution for atmospheric effects. The EIRP stability of a station transmitting digital services should be better than $\pm 0.5\text{dB}$.

The EIRP stability, although forming a mandatory requirement, will not normally be measured as part of the earth station verification tests. However, for the first 24 hours after initial service line-up, or when the PMOC has just cause to believe these stability limits have been exceeded, the PMOC will monitor the stability of the carrier.

2.4 SPECTRAL SHAPE

The spectral shape of the modulated carrier will be measured during the initial carrier line-up, and will also be performed on a regular basis by the PMOC.

There are no specific measurements to be performed by the system users themselves. However users should be aware that the spectral shape and hence the occupied bandwidth of the carrier needs to be carefully controlled in order to avoid unnecessary interference to other system users.

3 ADDITIONAL TESTS

Although the following the tests are not mandatory, SES reserve the right to request that they be performed if deemed applicable by SES.

Circumstances for these tests being performed are:

- SES decide that these or a subset of these tests are required on examination of the information provided on the antenna registration form.
- As a result of the mandatory tests, SES deem it necessary to perform additional test to verify the performance of the antenna.
- A customer has specifically requested that these or a subset of these tests are performed.

3.1 TX ANTENNA PATTERNS

3.1.1 Co-Polarised Antenna Pattern

This test procedure requires the PMOC to receive an unmodulated carrier transmitted from the AUT and to measure the transmit azimuth and elevation sidelobe patterns. Figure 3.1-1 illustrates the test configuration for measuring the Tx sidelobe patterns.

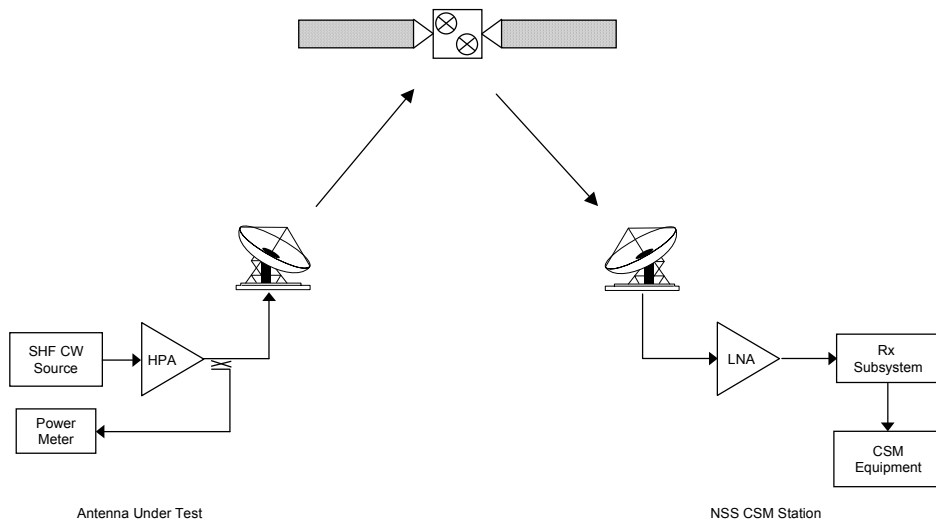

Figure 3.1-1: Tx Sidelobe Patterns Test Configuration

Prior to the commencing of the test, the PMOC will ensure that the test slot as defined in the test plan is clear and free for use. The PMOC will then configure the CSM to measure the co-polarisation and cross-polarisation components of the AUT's carrier. Also, the AUT should have measured its tracking velocity for azimuth and elevation, if possible, over the angular displacement of the measurement.

Under the control of the PMOC, the AUT will transmit a low-level test carrier at the test frequency and an initial power level 15dB below that defined in the test plan. The PMOC will then request that the AUT increase its power level until the nominal power level for the test is reached.

In co-operation with the PMOC, the AUT sweeps its antenna over angular displacements agreed with the PMOC (typically $\pm 15^\circ$ corrected). For antennas employing elevation over azimuth mounts, the azimuth angle needs to be corrected for the elevation angle using the formula below.

$$Az' = 2\text{Sin}^{-1}\left(\text{Sin}\left(\frac{Az}{2}\right) \cdot \text{Cos}(El)\right) \text{ degrees}$$

where: Az is the azimuth angle from boresight as read from the encoders (°)

El is the elevation angle (°)

Az' is the actual azimuth angle from boresight (°)

The PMOC measures the co-polarised Tx sidelobe pattern. On completion of the measurement, the PMOC will annotate the measured sidelobe patterns with the ITU-R mask, and will determine the percentage of sidelobes exceeding the mask.

3.1.2 Cross-Polarised Patterns

The measurement is performed in the same as the co-polarised patterns (ref: 3.1.1), with the exception that the cross-polarised pattern is measured by the PMOC.

3.2 RX ANTENNA PATTERNS

3.2.1 Co-Polarised Antenna Pattern

This test procedure requires the AUT to receive an unmodulated beacon, or alternatively an unmodulated carrier transmitted by PMOC, and to measure the receive azimuth and elevation sidelobe patterns. Figure 3.2-1 overleaf illustrates the test configuration for measuring the Rx sidelobe patterns.

Prior to the commencing of the test, the AUT should have measured its tracking velocity for azimuth and elevation, if possible, over the angular displacement of the measurement. The AUT then sweeps the antenna over required angular displacements (typically ±15° corrected), and measures the Rx sidelobe patterns.

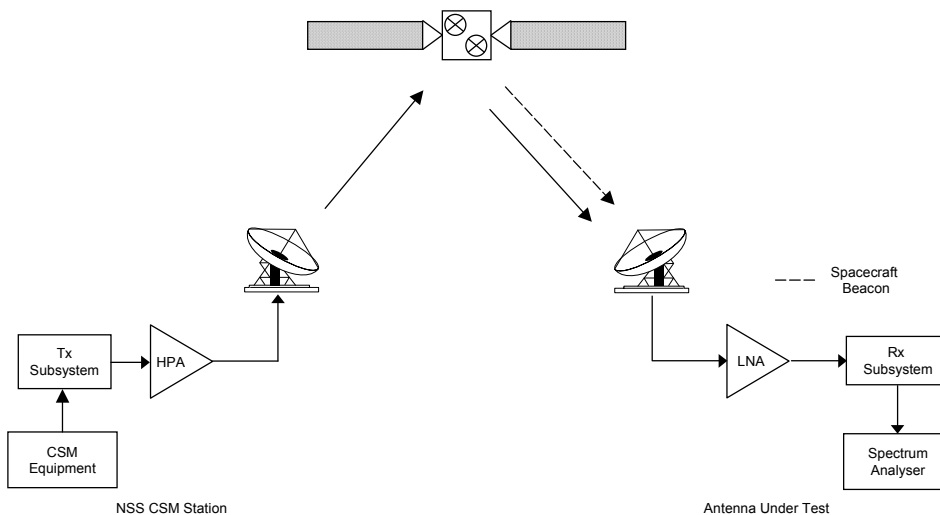

Figure 3.2-1: Rx Sidelobe Patterns Test Configuration

For antennas employing elevation over azimuth mounts, the azimuth angle needs to be corrected for the elevation angle using the formula below.

$$Az' = 2\text{Sin}^{-1}\left(\text{Sin}\left(\frac{Az}{2}\right) \cdot \text{Cos}(El)\right) \text{ degrees}$$

where: Az is the azimuth angle from boresight as read from the encoders ($^{\circ}$)

EI is the elevation angle ($^{\circ}$)

Az' is the actual azimuth angle from boresight ($^{\circ}$)

On completion of the measurement, the AUT should annotate the measured sidelobe patterns with the ITU-R mask, and determine the percentage of sidelobes exceeding the mask.

3.2.2 Cross-Polarised Antenna Pattern

The measurement is performed in the same as the co-polarised patterns (ref: 3.2.1), with the exception that the cross-polarised pattern is measured by the AUT.

3.3 TX CROSS-POLARISATION ISOLATION

3.3.1 Linearly Polarised

This test procedure requires the PMOC to receive an unmodulated carrier transmitted from the AUT and to measure the transmit cross-polarisation isolation. Figure 3.3-1 illustrates the Tx cross-polarisation test configuration.

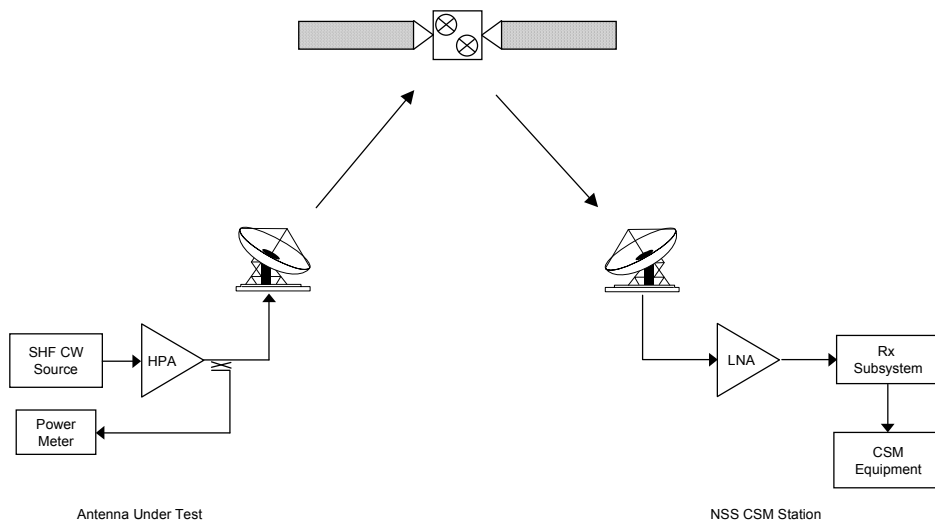

Figure 2.1-1: Tx Cross-Polarisation Isolation Test Configuration

Prior to the commencing of the test, the PMOC will ensure that the test slot as defined in the test plan is clear and free for use. The PMOC will then configure the CSM to measure the co-polarisation and cross-polarisation components of the AUT's carrier.

Under the control of the PMOC, the AUT will transmit a low-level test carrier at the test frequency and an initial power level 15dB below that defined in the test plan. If necessary, the PMOC will adjust the carrier level.

The PMOC will then verify that the AUT is on boresight by observing the change in the co-polarised carrier power level as the AUT is driven off boresight in azimuth and elevation.

Once the AUT has been verified at boresight, the PMOC will then optimise the AUT's polarisation angle by observing the power level of the cross-polarised component as the AUT rotates the feed, and determining the polarisation angle corresponding to the minimum power level of the cross-polarised component.

When the PMOC are satisfied that the polarisation angle has been optimised the AUT will increase the carrier power level, under the control of the PMOC, to the nominal power level required for the test as defined in the test plan.

In co-operation with the PMOC, the AUT is requested to move through a nine-point grid corresponding to the 0.5dB/1dB beamwidths of the antenna. At each point in the grid, the PMOC measures the co-polarised and cross-polarised components of the AUT's test carrier.

The PMOC then calculates the cross-polarisation isolation for each of the measured points and determines whether or not the AUT's cross-polarisation isolation meets the cross-polarisation isolation requirements specified by SES.

3.3.2 Circularly Polarised

The test configuration and method for circularly polarised antennas is identical to that of linearly polarised antennas (ref: 3.3.1), with the exception that there is no need to perform the polarisation angle optimisation, as this will have no effect.

3.4 RX CROSS-POLARISATION ISOLATION

3.4.1 Linearly Polarised

This test procedure requires the AUT to receive an unmodulated beacon or alternatively an unmodulated carrier transmitted from the PMOC, and to measure the receive cross-polarisation isolation. Figure 3.4-1 illustrates the Tx cross-polarisation test configuration.

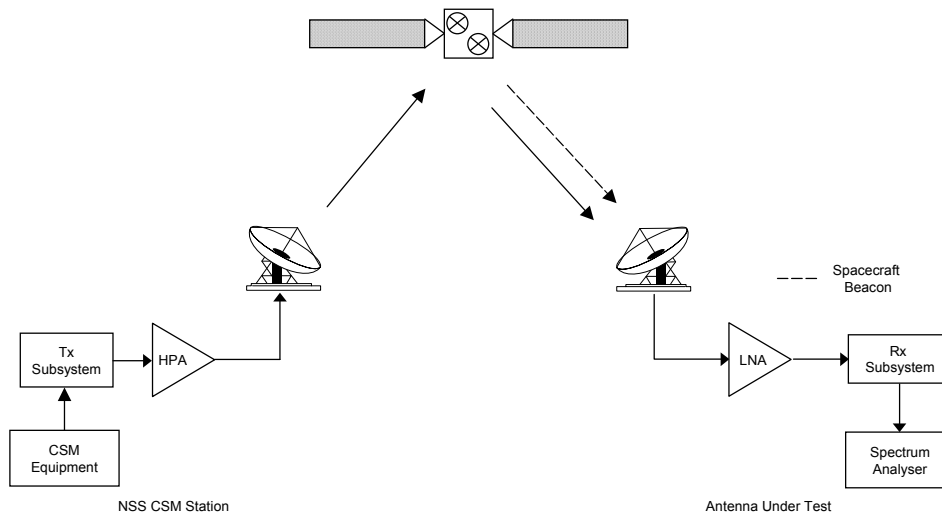

Figure 3.4-1: Rx Cross-Polarisation Isolation Test Configuration

Prior to beginning the measurement, the AUT will optimise its polarisation angle by observing the power level of the cross-polarised component as the feed is rotated, the polarisation angle is optimised when the power level of the cross-polarised component is at its minimum.

The AUT then moves through a nine-point grid corresponding to the 1dB beamwidth of the antenna. At each point in the grid, the AUT measures the co-polarised and cross-polarised components of the test carrier.

The AUT then calculates the cross-polarisation isolation for each of the measured points and determines whether or not the cross-polarisation isolation meets the cross-polarisation isolation requirements specified by the manufacturer.

SES has no mandatory requirements for Rx cross-polarisation isolation, but recommends that it meets the same requirements as the Tx cross-polarisation isolation.

3.4.2 Circularly Polarised

The test configuration and method for circularly polarised antennas is identical to that of linearly polarised antennas (ref: 3.4.1), with the exception that there is no need to perform the polarisation angle optimisation, as this will have no effect.

APPENDIX A: G/T MEASUREMENT PROCEDURES

A.1 G/T MEASUREMENT USING A SPECTRUM ANALYSER

Measurement of G/T of small antennas is easily and simply measured using the spectrum analyser method. For antennas with a diameter of less than 4.5 metres it is not normally necessary to point off from the satellite. A step in frequency would be required into one of the satellite transponder guard bands. However antennas with a G/T sufficiently large to enable the station to see the transponder noise floor either a step in frequency into one of the satellite transponder guard bands and/or in azimuth movement would be required.

The test signal can be provided from an SES beacon.

The procedure is:

- (a) Set up the test equipment as shown below. Allow half an hour to warm up, and then calibrate in accordance with the manufacturer's procedures.

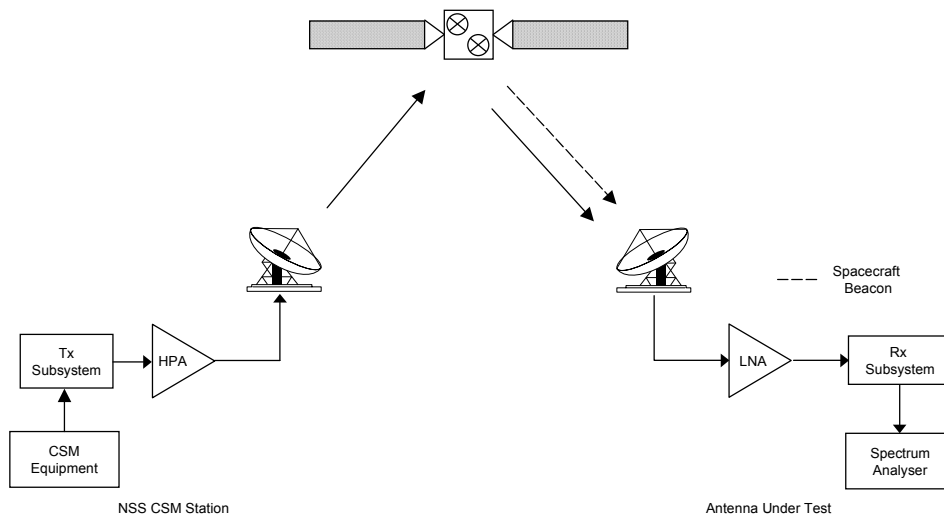

Figure A.1-1: GT – Spectrum Analyser Method

- (b) Adjust the centre frequency of your spectrum analyser to receive the SES beacon (data to be provided on the satellite used for testing)
- (c) Carefully peak the antenna pointing and adjust the polariser by nulling the cross polarized signal. You cannot adjust polarization when using the circularly polarized SES beacon.
- (d) Configure the spectrum analyser as follows:

Centre Frequency: Adjust for beacon or test signal frequency (to be advised). Use marker to peak and marker to centre functions.

Frequency Span: 100 KHz

Resolution Bandwidth: 1 KHz

Video Bandwidth: 10 Hz (or sufficiently small to limit noise variance)

Scale: 5 dB/div

Sweep Time: Automatic

Attenuator Adjust to ensure linear operation (typically 30 - 40 dB with VSAT receivers and nominal cable length (100'), less if external attenuator pads and/or signal splitters are used.). Adjust to provide the "Noise floor delta" described in steps 7 and 8.

(e) To insure the best measurement accuracy during the following steps, adjust the spectrum analyser amplitude (reference level) so that the measured signal, carrier or noise, is approximately one division below the top line of the spectrum analyser display.

(f) Record the frequency and frequency offset of the test signal from the nominal frequency:

For example, assume the nominal test frequency is 11750 MHz but the spectrum analyser shows the peak at 11749 MHz. The frequency offset in this case is -1 MHz.

(g) Change the spectrum analyser centre frequency as specified by SES so that the measurement is performed in a transponder guard band so that only system noise power of the earth station and no satellite signals are received. Set the spectrum analyser frequency as follows:

Centre Frequency = Noise slot frequency provided by the PMOC

(h) Disconnect the input cable to the spectrum analyser and confirm that the noise floor drops by at least 15 dB but no more than 25dB. This confirms that the spectrum analyser's noise contribution has an insignificant effect on the measurement. An input attenuation value allowing a "Noise floor Delta" in excess of 25 dB may cause overloading of the spectrum analyser input.

(i) Reconnect the input cable to the spectrum analyser.

(j) Activate the display line on the spectrum analyser.

(k) Carefully adjust the display line to the noise level shown on the spectrum analyser. Record the display line level.

(l) Adjust the spectrum analyser centre frequency to the test carrier frequency recorded in step (e).

(m) Carefully adjust the display line to the peak level of the test carrier on the spectrum analyser. Record the display line level.

(n) Determine the difference in reference levels between steps (l) and (j) which is the (C+N)/N.

(o) Change the (C+N)/N to C/N by the following conversion:

$$\left(\frac{C}{N}\right) = 10 \log_{10} \left(10^{\frac{\left(\frac{C+N}{N}\right)}{10}} - 1 \right) \text{ dB}$$

This step is not necessary if the (C+N)/N ratio is more than 20 dB because the resulting correction is less than 0.1 dB.

- (p) Calculate the carrier to noise power density ratio (C/No) using:

$$\left(\frac{C}{No}\right) = \left(\frac{C}{N}\right) - 2.5 + 10 \log_{10}(\text{RBW} \times SA_{\text{corr}}) \quad \text{dB}$$

The 2.5 dB figure corrects the noise power value measured by the log converters in the spectrum analyser to a true RMS power level, and the SA_{corr} factor takes into account the actual resolution filter bandwidth.

- (q) Calculate the G/T using the following:

$$\left(\frac{G}{T}\right) = \left(\frac{C}{No}\right) - (\text{EIRP}_{\text{SC}} - A_{\text{corr}}) + (\text{FSL} + L_a) - 228.6 \quad \text{dB / K}$$

where,

EIRP_{SC} – Downlink EIRP from satellite as measured by the PMOC (dBW)

A_{corr} – Aspect correction supplied by the PMOC (dB)

FSL – Free Space Loss to the AUT supplied by the PMOC (dB)

L_a – Atmospheric attenuation supplied by the PMOC (dB)

- (r) Repeat the measurement several times to check consistency of the result.